



Thin-Film Cascadable Amplifier 1 to 2000 MHz

Technical Data

UTO/UTC 2032 Series

Features

- **Frequency Range: 1 to 2000 MHz**
- **Medium Gain: 10.0 dB (Typ)**
- **Low VSWR**
- **Temperature Compensated**

Applications

- **IF/RF Amplification**

Description

The 2032 Series is a wideband thin-film bipolar RF amplifier using resistive feedback and active bias for temperature compensation and increased immunity to bias voltage variations. Low input/output VSWR is maintained by inductive tuning, and internal blocking capacitors couple the RF through the amplifier. The 2032 Series amplifiers are available in either the TO-8 hermetic case or connected TC-1A package.

Pin Configuration UTO—TO-8U

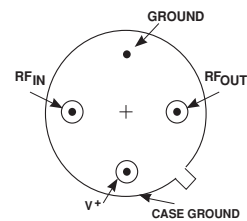

UTC—TC-1A

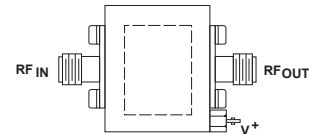

Schematic

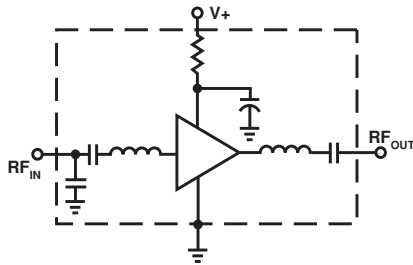

Maximum Ratings

Parameter	Maximum
DC Voltage	+17 Volts
Continuous RF Input Power	+13 dBm
Operating Case Temperature	-55 to +125°C
Storage Temperature	-62 to +150°C
"R" Series Burn-In Temperature	+125°C

Thermal Characteristics¹

θ_{JC}	105°C/W
Active Transistor Power Dissipation	216 mW
Junction Temperature Above Case Temperature	23°C
MTBF (MIL-HDBK-217E, A_{UF} @ 90°C)	797,500 Hrs.

Weight: (typical) UTO—2.1 grams; UTC—21.5 grams

Electrical Specifications

(Measured in 50 Ω system @ +15 VDC nominal unless otherwise noted)

Symbol	Characteristic	Typical $T_C = 25^\circ\text{C}$	Guaranteed Specifications		Unit
			$T_C = 0 \text{ to } 50^\circ\text{C}$	$T_C = -55 \text{ to } +85^\circ\text{C}$	
BW	Frequency Range	1-2000	1-2000	1-2000	MHz
GP	Small Signal Gain (Min.)	10.0	9.0	8.5	dB
—	Gain Flatness (Max.)	± 0.6	± 1.0	± 1.0	dB
NF	Noise Figure (Max.)	5.0	6.0	6.0	dB
$P_{1\text{dB}}$	Power Output @ +1 dB Comp. (Min.)	+7.50	+7.0	+6.5	dBm
—	Input VSWR (Max.)	<1.8:1	2.0:1	2.0:1	—
—	Output VSWR (Max.)	<1.4:1	2.0:1	2.0:1	—
IP_3	Two Tone 3rd Order Intercept Point	+17.0	—	—	dBm
IP_2	Two Tone 2nd Order Intercept Point	+23.0	—	—	dBm
HP_2	One Tone 2nd Harmonic Intercept Point	+28.0	—	—	dBm
I_D	DC Current	25	—	—	mA

Typical Performance Over Temperature (@ +15 VDC unless otherwise noted)

Key: +25°C —
+85°C - -
-55°C —

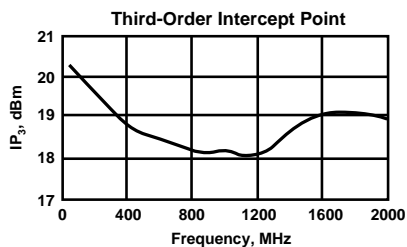
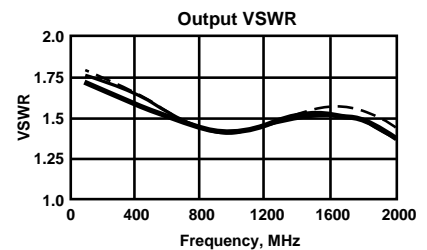
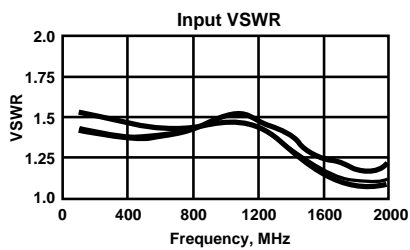
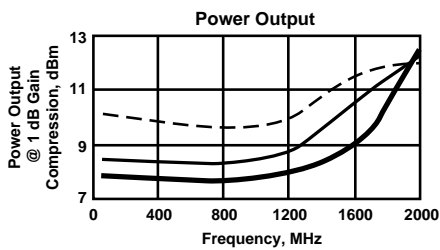
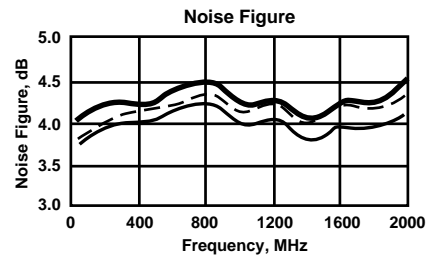
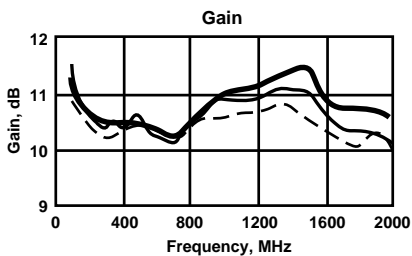

Automatic Network Analyzer Measurements (Typical production unit @ +25°C ambient)

Numerical Readings
Bias = 15.00 Volts

FREQUENCY MHz	VSWR IN	GAIN dB	PHASE DEGREES	PHASE DEV	GROUP DELAY ns	VSWR OUT	ISOLATION dB
100.0	1.26	10.45	166.48	-7.64	.00	1.62	18.02
200.0	1.29	10.39	154.11	-6.19	.35	1.59	18.22
300.0	1.32	10.35	141.35	-5.12	.36	1.58	18.22
400.0	1.36	10.39	128.99	-3.66	.33	1.58	18.32
500.0	1.40	10.44	117.02	-1.80	.33	1.57	18.42
600.0	1.46	10.46	105.27	.25	.32	1.56	18.60
700.0	1.50	10.50	93.48	2.30	.31	1.55	18.69
800.0	1.56	10.57	82.37	5.01	.34	1.55	18.83
900.0	1.60	10.71	70.04	6.48	.35	1.55	19.00
1000.0	1.63	10.87	57.02	7.27	.37	1.55	19.24
1100.0	1.64	11.05	43.12	7.18	.39	1.56	19.50
1200.0	1.61	11.20	28.58	6.47	.41	1.56	19.76
1300.0	1.56	11.29	13.37	5.09	.43	1.55	19.95
1400.0	1.48	11.33	-2.31	3.23	.43	1.53	20.00
1500.0	1.40	11.26	-17.82	1.55	.43	1.48	19.84
1600.0	1.34	11.10	-33.49	-.28	.44	1.41	19.59
1700.0	1.29	10.95	-49.56	-2.52	.45	1.35	19.25
1800.0	1.31	10.89	-65.62	-4.76	.44	1.31	18.95
1900.0	1.38	10.76	-81.80	-7.11	.46	1.32	18.65
2000.0	1.55	10.46	-99.32	-10.81	.51	1.41	18.52
2100.0	1.86	10.00	-118.20	—	.54	1.57	18.44
2200.0	2.33	9.26	-138.11	—	.56	1.77	18.60

S-Parameters
Bias = 15.00 Volts

FREQUENCY MHz	S ₁₁		S ₂₁		S ₁₂		S ₂₂	
	Mag	Ang	dB	Ang	dB	Ang	Mag	Ang
100.00	.186	179.5	10.505	166.7	-16.576	-6.6	.268	166.3
200.00	.184	179.2	10.452	154.2	-18.519	-12.5	.261	153.2
300.00	.183	179.4	10.393	141.6	-18.585	-19.2	.254	139.8
400.00	.180	-179.5	10.405	129.1	-18.655	-25.5	.249	126.7
500.00	.185	-177.8	10.410	117.4	-18.645	-32.5	.239	115.3
600.00	.190	-175.8	10.410	105.9	-18.672	-39.2	.227	103.3
700.00	.204	-175.2	10.426	94.4	-18.801	-46.0	.212	91.3
800.00	.220	-175.7	10.456	83.7	-18.855	-52.7	.202	78.7
900.00	.239	-178.3	10.570	71.8	-18.982	-58.5	.190	65.0
1000.00	.257	178.2	10.723	59.5	-19.201	-64.8	.184	49.7
1100.00	.267	172.4	10.906	46.1	-19.411	-71.3	.183	32.4
1200.00	.268	165.7	11.096	32.3	-19.628	-76.8	.189	13.7
1300.00	.257	157.8	11.236	17.4	-19.762	-81.5	.199	-5.4
1400.00	.232	149.7	11.306	2.2	-19.845	-86.1	.209	-24.5
1500.00	.201	141.9	11.242	13.1	-19.678	-91.0	.215	-42.0
1600.00	.165	134.8	11.088	-28.2	-19.386	-96.1	.213	-57.7
1700.00	.130	124.8	10.896	-43.7	-19.083	-101.6	.204	-69.8
1800.00	.096	109.6	10.809	-59.0	-18.775	-108.0	.184	-78.0
1900.00	.074	75.1	10.722	-73.9	-18.472	-114.9	.157	-80.1
2000.00	.085	23.5	10.576	-89.7	-18.191	-122.7	.132	-71.2
2100.00	.150	-12.3	10.340	-106.5	-17.919	-131.8	.139	-53.6
2200.00	.246	-34.2	10.002	-124.8	-17.733	-142.2	.188	-42.5
2300.00	.351	-61.3	9.410	-144.2	-17.726	-163.4	.267	-43.7
2400.00	.458	-67.1	8.497	-164.3	-17.862	-164.8	.327	-50.8
2500.00	.551	-81.4	7.273	176.0	-18.237	-176.1	.377	-59.9

Product Options

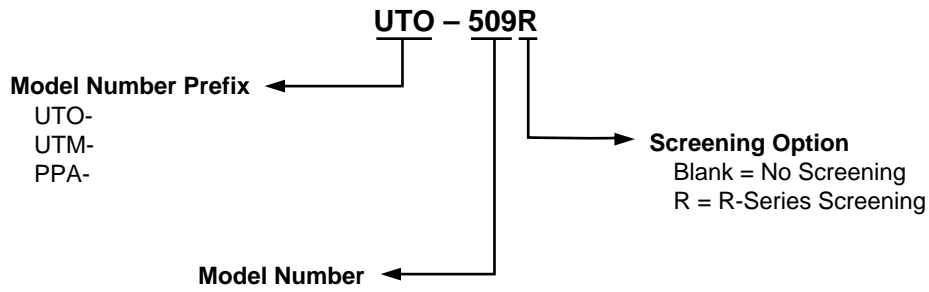

Note: R-Series screening is not available in the TC-1 case as the case is non-hermetic.

**Case Drawings
TO-8U**

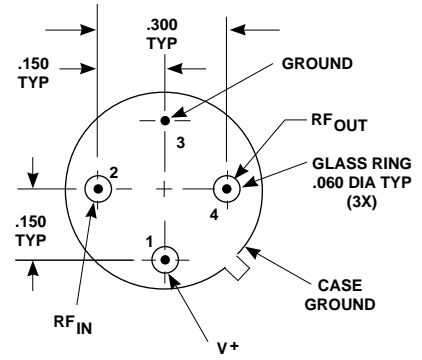
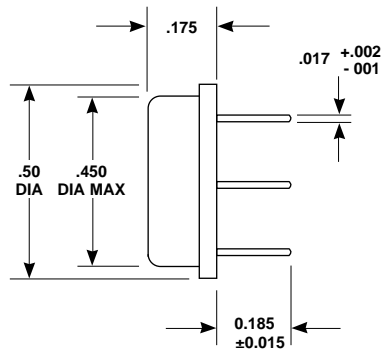
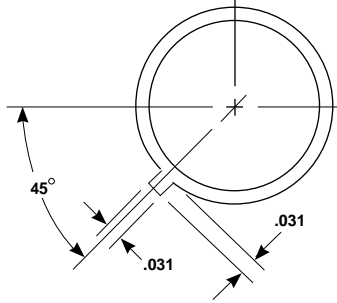

APPROXIMATE WEIGHT 2.1 GRAMS

- NOTES (UNLESS OTHERWISE SPECIFIED):
 1. DIMENSIONS ARE SPECIFIED IN INCHES
 2. TOLERANCES: xx $\pm .02$
 xxx $\pm .010$

Case Drawings TC-1

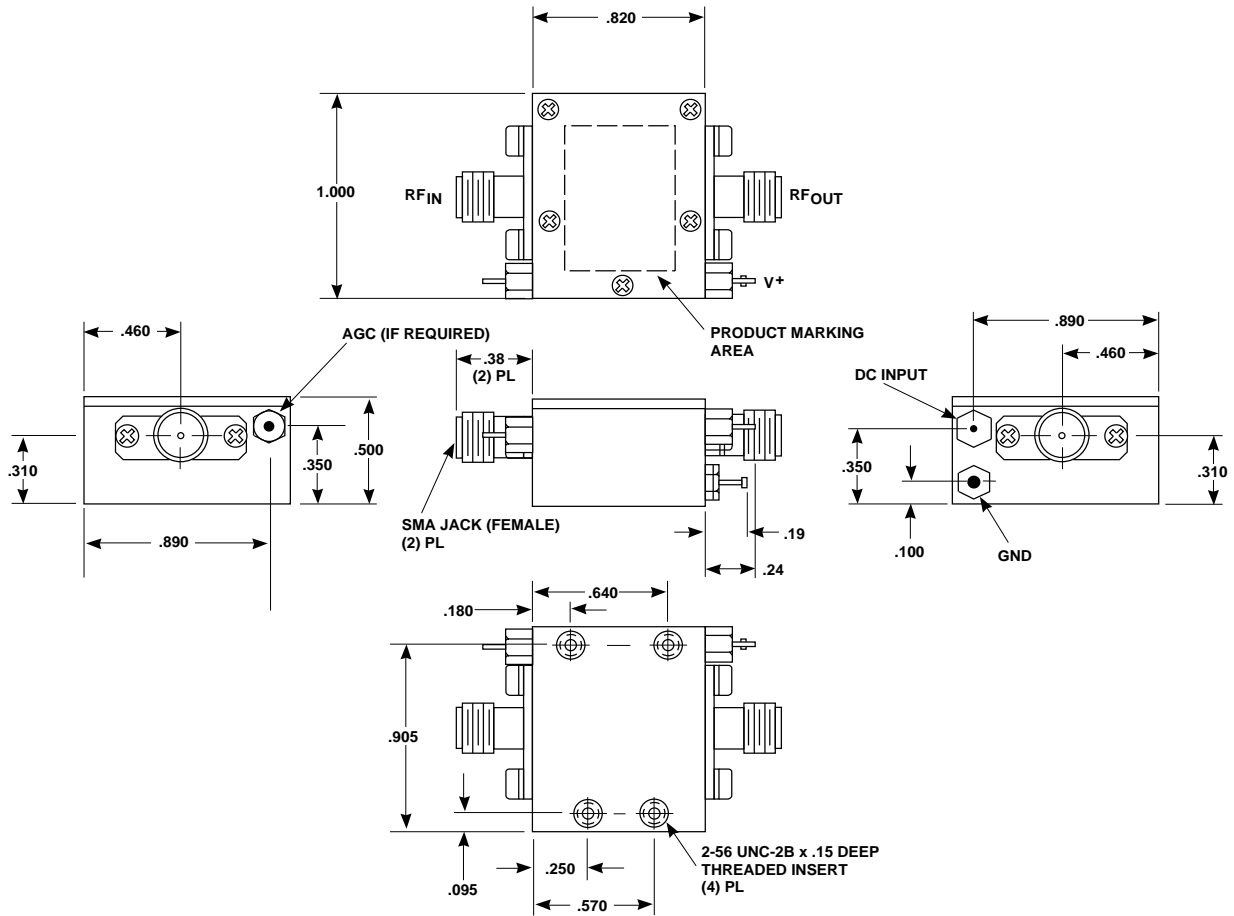

TYPICAL WEIGHT WITH CONNECTORS = 21.5 GRAMS

NOTES: 1. THE TC-1 CASE IS A NON-HERMETIC CASE.
2. THE ONLY CONNECTOR OPTION AVAILABLE FOR THE TC-1 CASE IS THE -1, SMA FEMALE CONNECTORS AT BOTH INPUT AND OUTPUT PORTS.

NOTES (UNLESS OTHERWISE SPECIFIED):
1. DIMENSIONS ARE SPECIFIED IN INCHES
2. TOLERANCES: xx ± .02
xxx ± .010

Contact Teledyne Microwave Solutions:
650-691-9800
650-962-6845 fax

Check for updates:
www.teledynemicrowave.com