



# Thin-Film Cascadable Amplifier

## 20 to 500 MHz

### Technical Data

### UTO/UTC 546 Series

#### Features

- **Frequency Range: 20 to 500 MHz**
- **High Output Power: +23.5 dBm (Typ)**
- **High Dynamic Range**
- **Temperature Compensated**

#### Applications

- **IF/RF Amplification**
- **Mixer Driver**

#### Description

The 546 Series is a thin-film RF bipolar amplifier using lossless feedback for optimum noise figure and high dynamic range. Resistive feedback and active bias compensate for temperature and voltage variations. Internal blocking capacitors couple the RF through the amplifier. The 546 Series amplifiers are available in either the TO-8 hermetic case or connected TC-1A package.

#### Pin Configuration

##### UTO—TO-8T

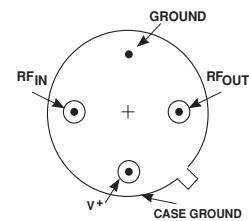

##### UTC—TC-1A

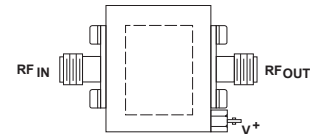

#### Schematic

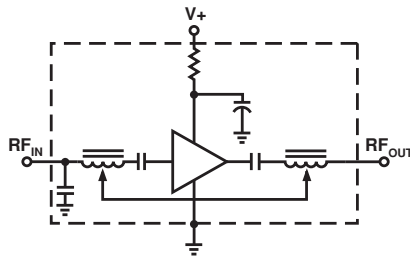

#### Maximum Ratings

Parameter	Maximum
DC Voltage	+17 Volts
Continuous RF Input Power	+13 dBm
Operating Case Temperature	-55 to +100°C
Storage Temperature	-62 to +150°C
"R" Series Burn-In Temperature	+100°C

#### Thermal Characteristics<sup>1</sup>

$\theta_{JC}$	55°C/W
Active Transistor Power Dissipation	840 mW
Junction Temperature Above Case Temperature	46°C
MTBF (MIL-HDBK-217E, $A_{UF}$ @ 90°C)	366,400 Hrs.

**Weight:** (typical) UTO—2.1 grams; UTC—21.5 grams

## Electrical Specifications<sup>1</sup>

(Measured in 50  $\Omega$  system @ +15 VDC nominal unless otherwise noted)

Symbol	Characteristic	Typical $T_C = 25^\circ\text{C}$	Guaranteed Specifications		Unit
			$T_C = 0 \text{ to } 50^\circ\text{C}$	$T_C = -55 \text{ to } +85^\circ\text{C}$	
BW	Frequency Range	10-500	20-500	20-500	MHz
GP	Small Signal Gain (Min.)	11.5	10.0	10.0	dB
—	Gain Flatness (Max.)	$\pm 0.2$	$\pm 0.5$	$\pm 0.5$	dB
NF	Noise Figure (Max.)	4.0	5.5	6.0	dB
P <sub>1dB</sub>	Power Output @ +1 dB Comp. (Min.)	+23.5	+23.0	+22.0	dBm
—	Input VSWR (Max.)	<1.7:1	2.0:1	2.0:1	—
—	Output VSWR (Max.)	<1.8:1	2.0:1	2.0:1	—
IP <sub>3</sub>	Two Tone 3rd Order Intercept Point	+35.0	—	—	dBm
IP <sub>2</sub>	Two Tone 2nd Order Intercept Point	+40.0	—	—	dBm
HP <sub>2</sub>	One Tone 2nd Harmonic Intercept Point	+50.0	—	—	dBm
I <sub>D</sub>	DC Current	110	—	—	mA

Note: 1. RF input and output connected – no blocking capacitor.

## Typical Performance Over Temperature (@ +15 VDC unless otherwise noted)

Key: +25°C ———  
+85°C - - - -  
-55°C ———

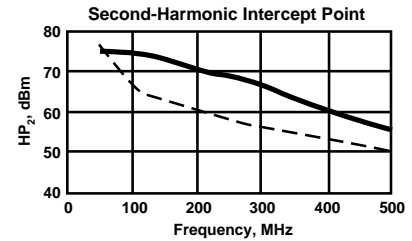
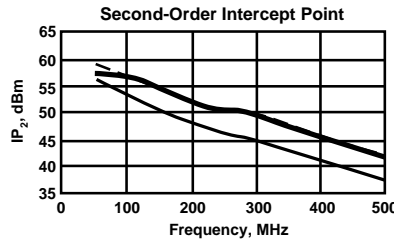
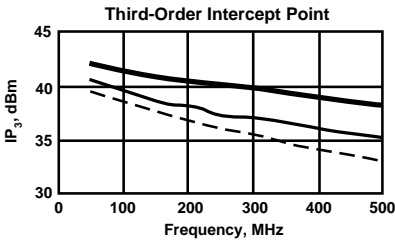
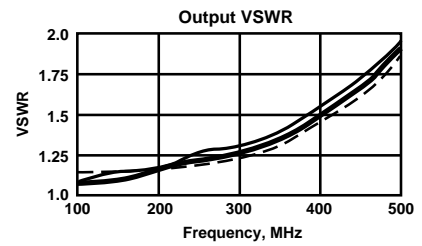
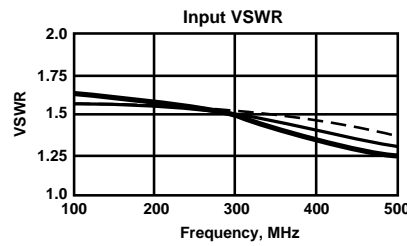
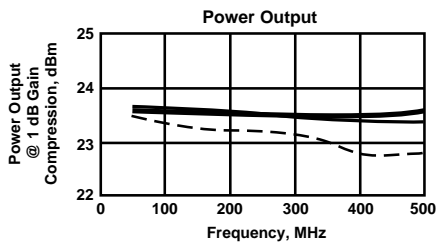
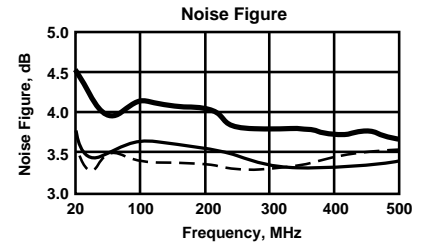
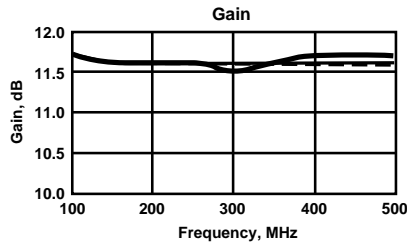

**Automatic Network Analyzer Measurements** (Typical production unit @ +25°C ambient)

**Numerical Readings**
**Bias = 15.00 Volts**

FREQUENCY MHz	VSWR IN	GAIN dB	PHASE DEGREES	PHASE DEV	GROUP DELAY ns	VSWR OUT	ISOLATION dB
100.0	1.70	10.80	153.07	-.41	.00	1.48	20.21
150.0	1.69	10.75	138.16	-.34	.83	1.56	20.25
200.0	1.72	10.75	123.16	-.39	.81	1.64	20.14
250.0	1.72	10.77	108.84	.26	.80	1.71	19.93
300.0	1.73	10.78	94.21	.60	.82	1.77	19.71
350.0	1.71	10.74	79.48	.84	.82	1.82	19.42
400.0	1.70	10.70	64.55	.88	.85	1.82	19.26
450.0	1.70	10.59	48.75	.05	.90	1.79	19.06
500.0	1.74	10.46	32.23	-1.49	.95	1.77	16.89
550.0	1.86	10.20	14.70	—	1.00	1.72	18.76
600.0	2.10	9.81	-3.69	—	1.05	1.63	18.85
650.0	2.51	9.26	-22.99	—	1.09	1.52	19.01
700.0	3.15	8.43	-42.99	—	1.09	1.38	19.51
750.0	4.09	7.38	-62.09	—	1.07	1.19	20.14
800.0	5.46	5.99	-81.67	—	1.05	1.12	21.13
850.0	7.35	4.30	-100.03	—	.99	1.31	22.42
900.0	9.75	2.35	-117.21	—	.95	1.62	24.04
950.0	12.78	.25	-134.39	—	.86	2.00	25.66
1000.0	16.33	-1.94	-148.23	—	.73	2.44	27.55

LINEARIZATION RANGE: 100.0 to 500.0 MHz

**S-Parameters**
**Bias = 15.00 Volts**

FREQUENCY MHz	S <sub>11</sub>		S <sub>21</sub>		S <sub>12</sub>		S <sub>22</sub>	
	Mag	Ang	dB	Ang	dB	Ang	Mag	Ang
100.00	.261	-170.5	10.828	153.5	-19.567	154.8	.166	-174.6
200.00	.250	-167.7	10.794	124.1	-19.406	123.1	.212	160.6
300.00	.241	-161.0	10.804	95.3	-19.034	93.6	.254	125.0
400.00	.239	-148.7	10.665	65.6	-18.778	64.6	.282	82.0
500.00	.278	-132.3	10.310	34.1	-18.614	34.4	.298	32.3
600.00	.378	-122.4	9.543	-.5	-18.744	2.5	.299	-21.0
700.00	.524	-122.3	8.190	-37.8	-19.444	-31.8	.242	-73.6
800.00	.684	-129.3	5.958	-75.1	-20.911	-66.0	.086	-131.5
900.00	.811	-139.5	2.546	-110.5	-23.611	-97.7	.146	30.6
1000.00	.889	-149.2	-1.652	-142.0	-26.836	-124.7	.355	-9.0

## Product Options

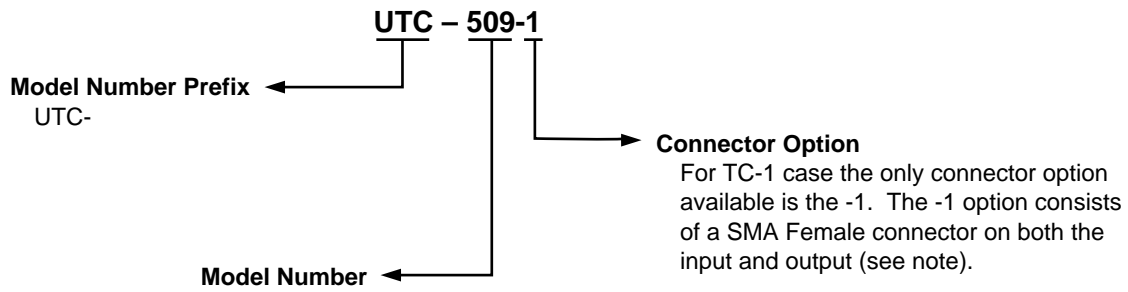
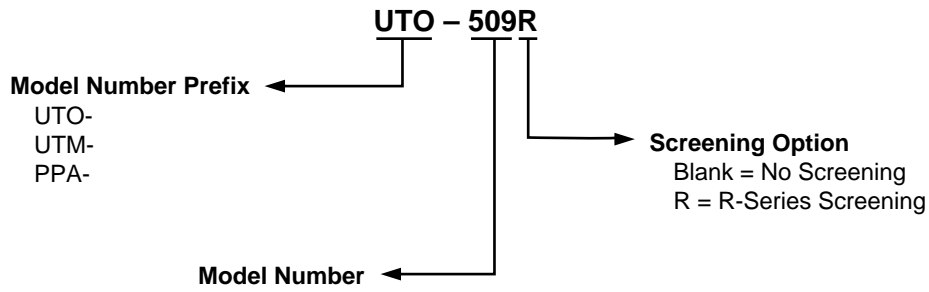

Note: R-Series screening is not available in the TC-1 case as the case is non-hermetic.

**Case Drawings  
TO-8T**

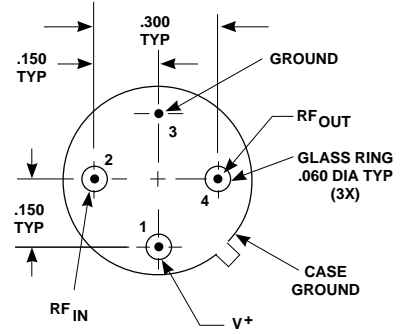
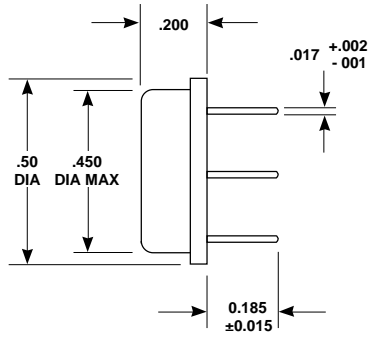
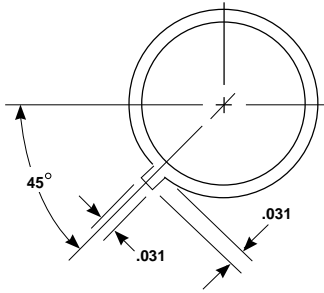

APPROXIMATE WEIGHT 2.1 GRAMS

- NOTES (UNLESS OTHERWISE SPECIFIED):**  
 1. DIMENSIONS ARE SPECIFIED IN INCHES  
 2. TOLERANCES:   xx ± .02  
                       xxx ± .010

# Case Drawings TC-1

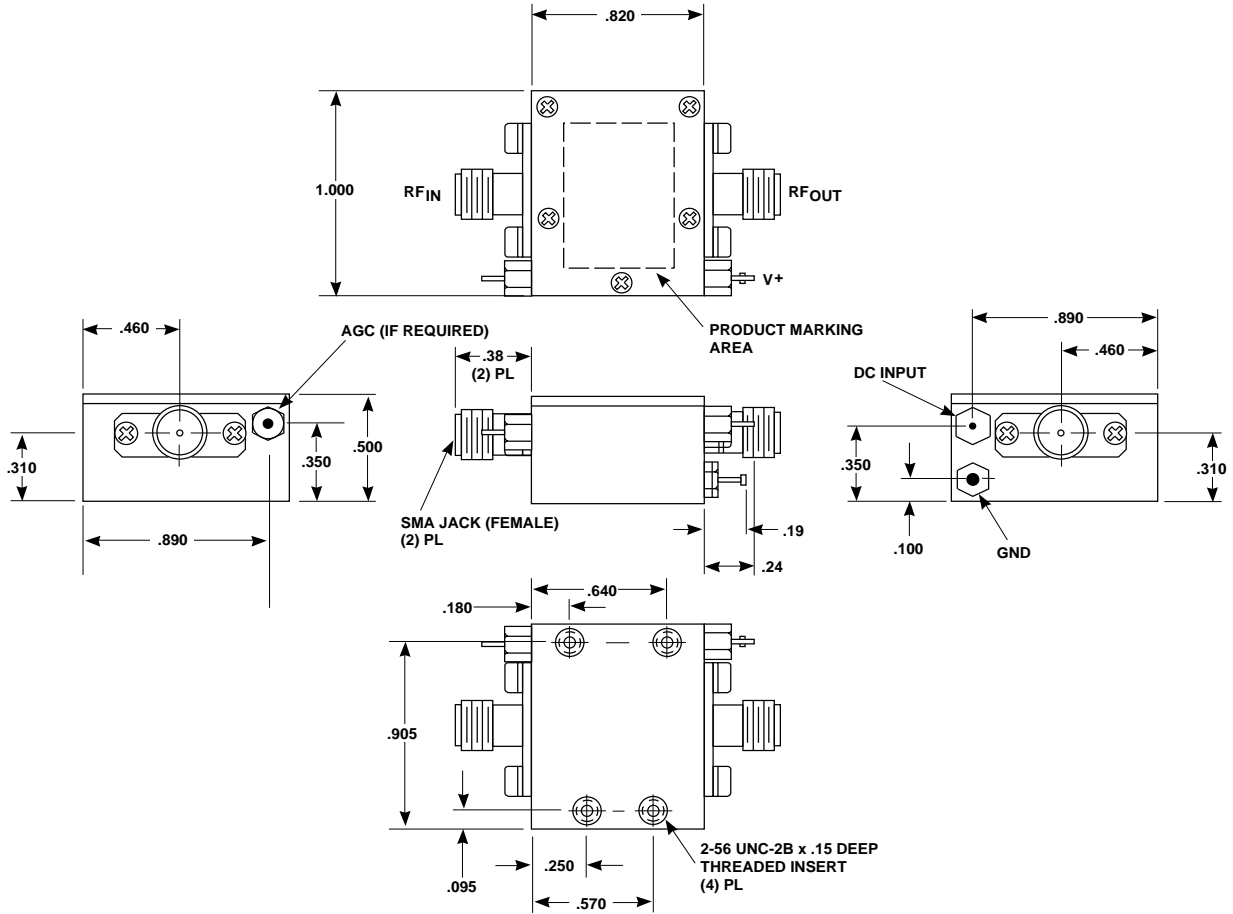

TYPICAL WEIGHT WITH CONNECTORS = 21.5 GRAMS

- NOTES: 1. THE TC-1 CASE IS A NON-HERMETIC CASE.  
 2. THE ONLY CONNECTOR OPTION AVAILABLE FOR THE TC-1 CASE IS THE -1, SMA FEMALE CONNECTORS AT BOTH INPUT AND OUTPUT PORTS.

- NOTES (UNLESS OTHERWISE SPECIFIED):  
 1. DIMENSIONS ARE SPECIFIED IN INCHES  
 2. TOLERANCES: xx ± .02  
 xxx ± .010

Contact Teledyne Microwave Solutions:  
 650-691-9800  
 650-962-6845 fax

Check for updates:  
[www.teledynemicrowave.com](http://www.teledynemicrowave.com)